

FLOWCODE3

NO CODING, NO LIMITS...

- Microcontroller development software
- Easy to use graphical interface
- Fast and flexible
- PICmicro and AVR devices

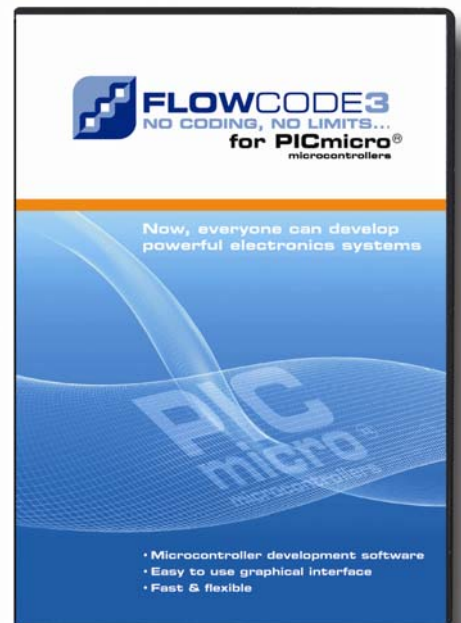
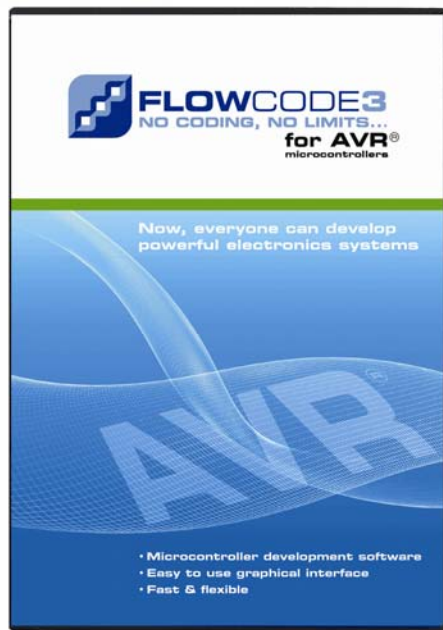

Introduction

Flowcode 3 is one of the **World's** most advanced graphical programming languages for microcontrollers.

The great advantage of Flowcode is that it allows those with little experience to create complex electronic systems in minutes.

Flowcode achieves this in two steps: firstly students drag and drop flowchart symbols onto the screen, fill in the dialog boxes when prompted. Then Flowcode compiles the flow chart into code that is downloaded to a microcontroller which executes the program.

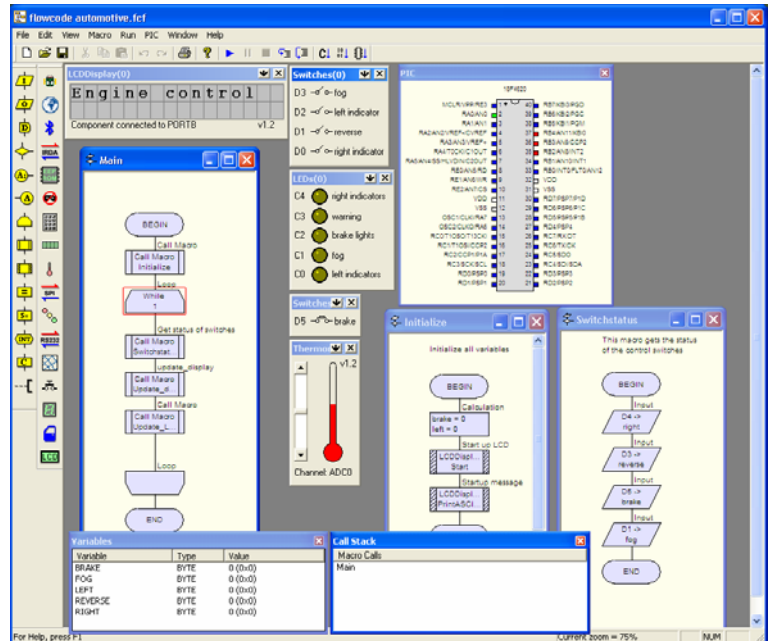

BENEFITS

- **Save time and money** Flowcode facilitates the rapid design of electronic systems based on microcontrollers.
- **Easy to use interface** Simply drag and drop charts on screen to create a electronic system without writing traditional code line by line.
- **Fast & flexible** Flowcode has a host of high level component subroutines which means rapid system development. The flowchart programming method allows users of all abilities to develop microcontroller programs.
- **Error free results** Flowcode works. What you design and simulate on screen is the result you get when you download to your microcontroller.
- **Open architecture** Flowcode allows you to view commented C and ASM code for all programs created. Access circuit diagram equivalents to the system you design through our datasheets and support material.
- **Fully supported** Flowcode is supported by a wide range of materials for learning about, and developing, electronic systems.

Flowcode now supports both PICmicro microcontrollers and AVR microcontrollers.

"Flowcode is great for students with no experience at all to get acquainted with electronics and programming in a very fast and fun way."

*Bart Huyskens
St Joseph's College, Belgium*

"The newer Flowcode and E-blocks offer the potential to make the learning of Microprocessor Systems and Electronics far more interesting."

*Malcom Newton
Isle of Man College, UK*

The design process

Design

Flowcode contains standard flow chart icons and electronic components that allow you to create a virtual electronic system on screen. Use the drag and drop interface to create a program and click on each icon and component to set the actions and properties you need. The range of components is large and includes simple switches and LEDs, communication bus interfaces like I²C and SPI, and more advanced components such as Bluetooth and internet servers.

- Easy to use interface
- Allows complex systems to be developed and managed quickly
- Supports most PICmicro, AVR and Atmel ARM microcontrollers

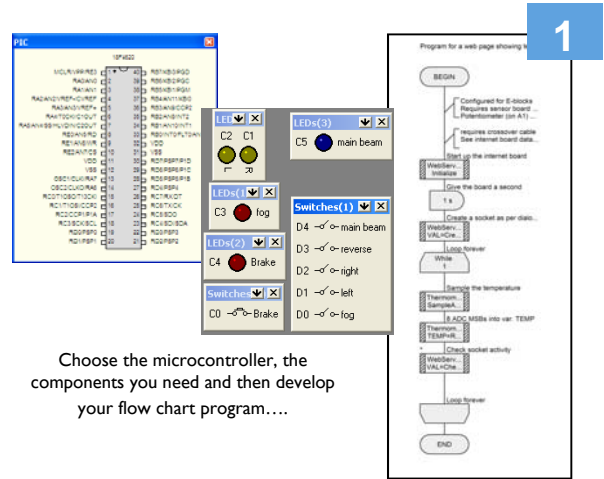

Choose the microcontroller, the components you need and then develop your flow chart program...

Simulate

Once your system is designed you can use Flowcode to simulate it in action. Menu controls allow you to step through each icon in the program and see the effects on the on-screen components, and on microcontroller itself. Test the system's functionality by clicking on switches or altering sensor values, and see how your program manages the changes in the electronic system.

- Simulation aids understanding
- Debug before download
- Shorten the design cycle

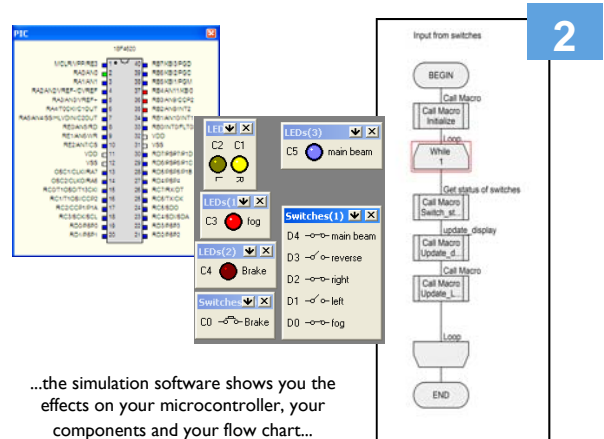

...the simulation software shows you the effects on your microcontroller, your components and your flow chart...

Download

When you are satisfied with your design click one button to send the program to your microcontroller device. Flowcode produces standard Hex code for ARM AVR and PICmicro microcontrollers. Flowcode is directly compatible with the E-blocks range of modular electronics modules.

- Compiles to C then ASM then Hex
- Link in your own C or ASM files
- Immediately download to your programmer

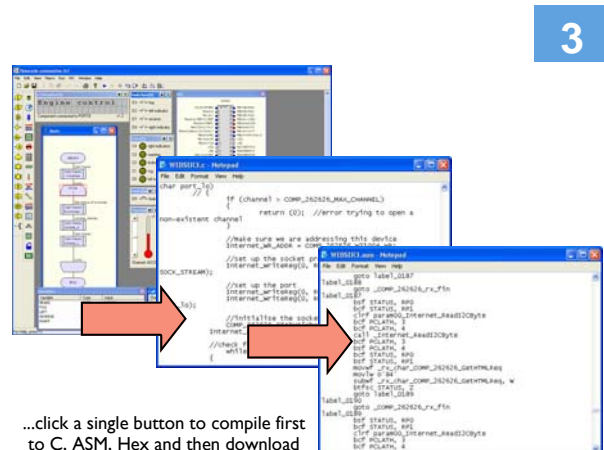

...click a single button to compile first to C, ASM, Hex and then download your code to your programmer.

Flowcode users

Flowcode is used in education and industry. Its comprehensive functionality meets the needs of today's technology educators and industrial designers.

Flowcode in industry

Industrial users vary from those just starting to use microcontrollers, to experienced systems engineers using Flowcode for small projects, prototyping, and de-skilling the design process.

- **Quick projects:** Flowcode is used even by experienced C code programmers because it is the quickest way of getting programs up and running.
- **Managing projects:** Flowcode is used as a 'front end' to manage complex projects containing C code. This allows engineers to de-skill the design process with one programmer developing core routines and another managing the user interface, ergonomics and program flow.
- **Rapid prototyping:** the tight integration of E-blocks and Flowcode allows incredibly rapid 'proof of concept' prototypes to be developed for customer surveys and specification development.
- **Open architecture:** The open architecture of E-blocks and Flowcode are designed to save engineers time in the design process: use our off the shelf software component designs with our off the shelf E-blocks hardware components to shorten the design cycle.

Flowcode in education

Educators incorporate Flowcode into their Electronics, Computer Science and Technology courses for many reasons including:

- **Fundamentals of programming:** Flowcode is an ideal tool for learning the fundamentals of programming. The process of building programs using drag and drop and point and click, allows students to understand program structure and flow without getting bogged down in syntax and language.
- **Fundamentals of electronics design:** in using Flowcode students are introduced to the concepts of system design, of inputs, outputs and processes. Students also learn about microcontroller circuitry and operation.
- **A precursor to C:** Flowcode is designed as a precursor to C programming - which many students find difficult. Flowcode introduces students to the concepts of programming and prepares them for the principles used in C programming.
- **Motivation:** Flowcode allows students to go further, faster, and develop projects which utilise the technology they use every day like mobile phones, MP3 players, GPS etc. Flowcode motivates students to want to learn more about electronic system design.



Flowcode and E-blocks have been adopted by Belgian schools for post 16 education in electronics. Shown here is the electronics teaching lab at St Joseph's Academy near Brecht.

TE-60-3

Support

Whether you are in education or industry you will find that there are a wide range of resources available to help gain knowledge on how Flowcode is used, programming concepts, microcontroller techniques and circuits.

- **In-package support:** Flowcode is shipped with a comprehensive help file covering all Flowcode functions. Over 30 example files are included with full descriptions.
- **Free web based courseware:** on our web site you will find a number of free web based courseware applications which cover not only how Flowcode is used but also cover the basics of microcontrollers, and how they are used in electronic systems,
- **Forums:** Online forums are used as a mechanism for building a knowledge base on Flowcode. Our engineers answer all questions on the forums on a daily basis.
- **Tutorial manuals:** for more advanced topics, such as Bluetooth, CAN, and TCP/IP, are available.
- **Technical support:** as you would expect our engineers provide free technical support for functional problems with Flowcode.



Tutorial manuals cover more advanced topics like using Flowcode to teach and learn TCP/IP, Bluetooth and CAN

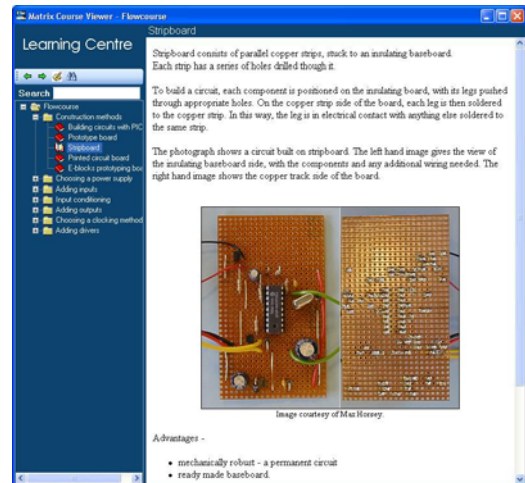

The Flowcode / E-blocks Learning Centre includes several web based tutorials and videos supporting Flowcode users

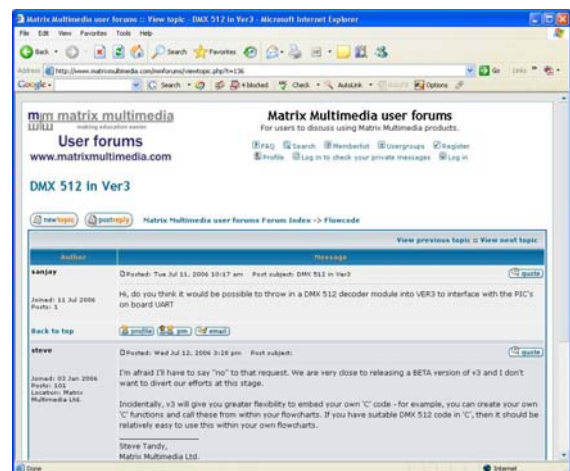

Web based forums, covering a variety of topics, are monitored by our technical support team on a daily basis

Case study - Flowcode in education

1

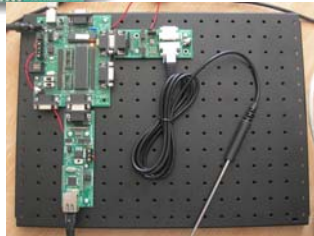

Our Internet board is used as part of an E-blocks prototyping system.....

Together Flowcode and E-blocks have the capability to provide access to complex electronics systems for those without programming, or electronics design experience. These images show you how.

The system shown here allows students to publish a web page showing the value of a real world sensor - in this case a temperature sensor. Students learn how an embedded internet system can be used for control and monitoring and combine this with Java programming exercises to produce graphs showing temperature over time.

Additional Flowcode subroutines allow students to dig deeper and learn about TCP/IP packet structure, and protocols.

2

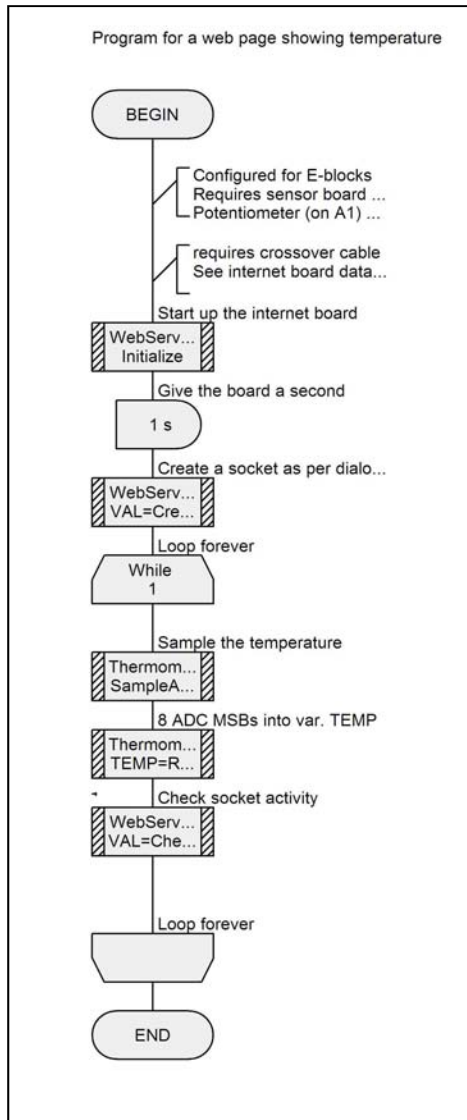

...here is the complete program...

3

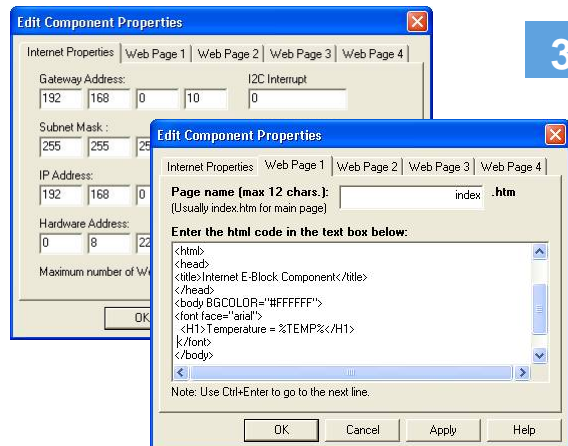

...students click on flowchart icons and set properties of macros as appropriate- including the HTML ...

4

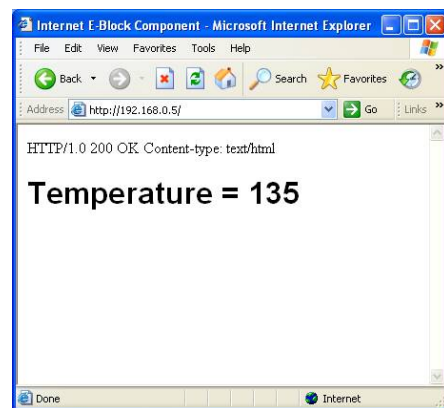

...the results can be seen at the appropriate IP address using Windows Explorer on a PC.

Case study - Flowcode in industry

Flowcode's inbuilt library of components, and tight integration with our E-blocks hardware modules, makes it ideal for rapid development of products and for proof of concept. This is not limited to programming novices: many industrial customers are experienced C coders but use Flowcode to get projects up and running and to manage their projects.

Here are some examples of what can be produced with Flowcode using E-blocks as a hardware platform:

1. The electronic bug uses mobile phone technology. A small patch circuit contains a microphone and amplifier that feeds into a Sony GSM module with SIM card. A PICmicro MCU Multiprogrammer, programmed with Flowcode, is used to detect an incoming call and then channel local sound to the incoming caller who can hear what is said in the room. Keypad and LCD allow various set ups with dial out at pre-determined times.

2. This medical electronics project shows an ECG sensor system. ECG data is gathered using a sensors board plugged into a PICmicro MCU Multiprogrammer. This houses a PIC16F877 programmed with Flowcode. Data is fed directly to a PC using an RS232 board and logged using a Visual Basic program. A Keypad and LCD display provide control of the system.

3. This simple MP3 player can be created from an 18 series PICmicro programmed with Flowcode. The PICmicro device connects to an SD card reader, and an MP3 decoder board. A keypad and LCD provide control of the unit which stores 125 songs.

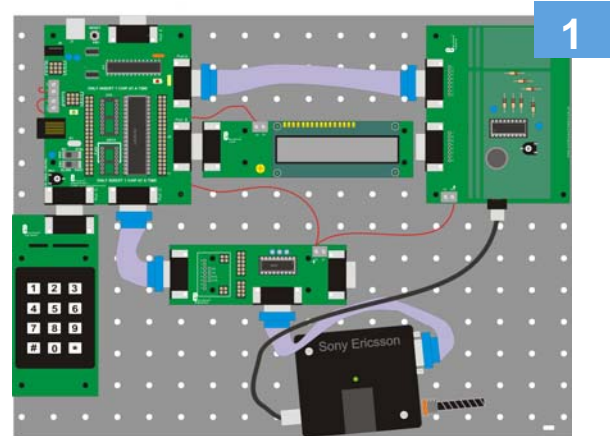

The electronic bug

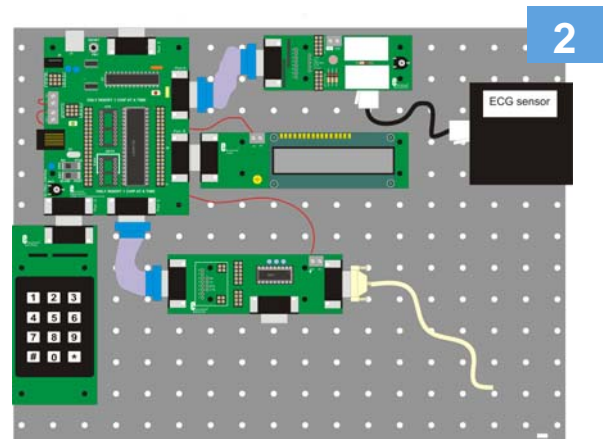

ECG sensor

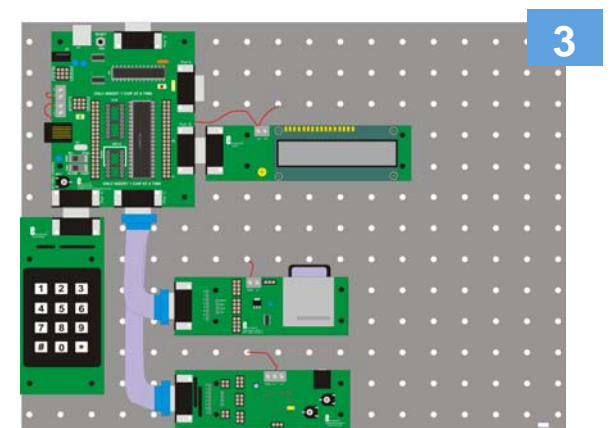

MP3 player

Licensing and versions

Flexible licensing

There are several versions of Flowcode 3 that you can see in the table on the right. These differ in functionality and price. The terms used are explained below.

Code limits

For the AVR version of Flowcode there are no code size limits for any version. For the Free PICmicro version the code will limit to 2KB of compiled and assembled code (18 series PICmicro limit is 4K). For the PICmicro Student version the code will limit to 4KB of compiled and assembled code (18 series PICmicro limit is 8K).

Limited components

Free versions do not have all components. Limited component versions all have LED, Switch, ADC, LCD, 7-segment display, Keypad, Quad 7-segment display, Burglar alarm, Buggy and Formula Flowcode. These versions cannot have more components added to them as free downloads. Other versions include all components.

Free version

This well featured version allows you to verify that Flowcode will provide the functions you need and is also suitable for use with hardware devices like the Formula Flowcode robot and ECIO. This is a fully working version of Flowcode that has some limitations. For Flowcode for PICmicro MCUs the demo version will produce hex code for only the following: 16F628A, 16F84A, 16F877A, 18F2220, 18F4431, Formula Flowcode, and ECIO. Free versions are limited to around 50 usable icons and also have code size limitations for PICmicro microcontrollers.

Student/ home version

The student PICmicro version is limited in the compiled code size it can produce and in the number of Flowcode components provided: communications functions are not supported. The AVR student version is limited in Flowcode components but has no code size limit.

Pro version

The Pro version includes all functions, components, full code compilation size and is licensed for commercial use. Industrial users who need more than one licence will need to purchase each licence separately.

Multuser education

Multuser versions are fully functional like the Pro version, but these are for educational (non-commercial) use only. Only 10 and 50 user versions are available. Those requiring between 10 and 20 users will need to purchase 2 off 10 user versions.

	Free version	Flowcode Student	Flowcode Pro	Flowcode 10 concurrent users	Flowcode 50 concurrent users
Unlimited icons	N	Y	Y	Y	Y
Code size limit*	2K	4K	N	N	N
All devices	N	Y	Y	Y	Y
All components	N	N	Y	Y	Y
Licence for commercial use	N	N	Y	N	N
Multi-user licence for education	N	N	N	Y	Y
Retail price**	£0	£39	£99	£350	£699

*Code size limit only applies to PICmicro versions. Other versions use limited icon numbers to limit functionality.

**These target prices are exclusive of tax and any applicable postage charges, and may vary slightly from one region to another.

Upgrading licences

Upgrades from one type of licence (e.g. Student to Pro) to another are simply the price difference.

Version 2 to Version 3 upgrade

Upgrades from version 2 to version 3 will be charged at 50% of the version 3 price.

Version 1 to Version 3 upgrade

Upgrades from version 1 to version 3 will be charged at 65% of the version 3 price.

PIC to AVR (or AVR to PIC) upgrade

Customers who have a PIC version and also want an AVR version will be charged at 50% of the AVR price.

Upgrade procedure

Please contact Matrix Multimedia or one of our dealers with your old serial number which is found on the inside of your CD ROM case.

Buying online

The only downloadable version available is the free version. Copies of Flowcode for purchase are only available in CD ROM form from Matrix or an authorised dealer.

Activation

Each product will need activating with a code issued by Matrix. An internet connection is recommended for this.

New features in version 3

The step from Flowcode 2 to Flowcode 3 is large with the software being improved in many areas. The improvements have been made with several themes in mind as you can see here:

Graphical User Interface improvements

Flowcode 3 has a number of enhancements over version 2 which makes it easier to design your program

- Making the most of your monitor real estate:
 - Zoom: Multiple zoom levels, zoom to fit
 - Tiling: horizontal tile, vertical tile
 - Smaller PICmicro MCU on-screen device
- Helping you produce easier to read flow charts:
 - Screen icons: new graphics, description now inside icons, better comments, more icons per screen viewable
 - Screen appearance: user selected icon shading, and background colour
 - Hardware and software macros now have separate icon graphics now known as: 'macro' and 'hardware macro'
- Helping you produce better documents and output:
 - New features for printing include Print Preview, and print to screen zoom setting
 - Flowcharts can be exported to JPEG or BMP for incorporation into documents
 - Tile horizontal and Vertical and auto arrange for multiple macro viewing

Improvements to help learners

Flowcode has new features that help users to learn programming and help them migrate to the C language when ready

- Features to help users learn C
 - All icons have bubble help to display icon function
 - Icons can also produce equivalent C code of each icon as bubbles
 - Students can view the C code equivalent of the whole program
 - Students can view the Assembly code equivalent of the whole program
- Screen layout and save:
 - Screen layout is preserved on save to allow educators to build more relevant examples
- Tutorial files
 - Descriptions now included
 - Makes use of features such as labelled components to add context

Multilingual support

- Main program and help file: English, French, Dutch, German, Spanish, Portuguese, Greek.
- Main program but not help file: Finnish, Romanian, Italian, Greek, Hebrew, Danish, Chinese, Slovak, Hungarian.

Software functionality improvements

New features in Flowcode 3 make it easier to create your programs and allows you to take advantage of more powerful, larger microcontrollers.

- Debugging
 - A better range of simulation speeds allows you to see your program working before downloading it to the PICmicro microcontroller
 - Alter variables whilst simulation is paused
- Type and variables:
 - Support for 16 bit numbers and arithmetic, choice of types includes CHAR, INT and STRING
 - Support for hexadecimal and binary numbers in all dialogue boxes
 - Full support for strings including string manipulation commands like ADD, LEFT, RIGHT
- Improvements to icons and their functionality:
 - New string process icon supports string manipulation
 - Interrupt icon supports a larger range of interrupts as well as custom interrupt definition. Each interrupts run a macro of your choice.
 - Improved Delay icon with a much greater range of delays
 - While icon can operate for a defined number of times
 - New string process icon supports string manipulation
- Subroutines can now have parameters passed to them, and returned
- Larger range of supported devices now includes 18 series PICmicro microcontrollers - see technical specification for full list.
- Undo and Redo commands
- Improved C compiler

Component improvements

New components have been introduced to allow you to incorporate a greater range of devices into your electronic system

- LCD: greater range of LCD types supported including 40 character - 2 line, 20 character, 4 line etc.
- Full LCD functions now supported with scroll and other features.
- Switches: can now be labelled, options for display vertical and horizontal, left to right or right to left.
- LEDs: can now be labelled, options for display vertical and horizontal, left to right or right to left.
- New PWM (Pulse Width modulation) component for motor control.
- Analogue components available now include thermometer, dial, or slider
- Target communications components now include RS232, I²C, Internet web server, Internet TCP/IP, Bluetooth, CAN bus and LIN bus

Cross platform development

Programs written for the PICmicro MCU can be exported and imported into Flowcode for AVR microcontrollers, and vice-versa. This means that programs written for one microcontroller can be used in another.

Technical specification

Flow chart icons

Input, Output, Delay, If, Connection point, Goto connection point, While, Macro, Component macro, Calculation, String calculation, Interrupt, C/ASM icon, Comment.

Virtual systems

Buggy, Burglar alarm, Formula Flowcode

Standard components

LED, Switch, Sensor, LCD, 7-segment display, Keypad, Quad 7-segment display.

Advanced components

Advanced components include: SPI bus, I²C bus, Internet, Webserver, CAN bus, LIN bus, EEPROM, IrDA, Bluetooth, PWM, AddDefines and RS232. Other components may be added to this list.

Technical requirements

Windows XP, Vista.

Output

Produces C code, ASM code and hex code compatible with the target microcontroller.

Language support (as of Oct 2007)

Full translations (inc. help file):

Dutch, English, French, German, Greek, Spanish, Portuguese

Full translations (no help file):

Danish, Hungarian, Italian, Romanian, Slovakian

Partial translations (still waiting for updates):

Chinese, Finnish

Target microcontrollers - PICmicro

12F508, 12F509, 12F510, 12F609, 12F615, 12F629, 12F635, 12F675, 12F683

16F505, 16F506, 16F610, 16F616, 16F627, 16F627A, 16F628, 16F628A, 16F630, 16F631, 16F636, 16F639, 16F648A, 16F676, 16F677, 16F684, 16F685, 16F687, 16F688, 16F689, 16F690, 16F716, 16F72, 16F73, 16F737, 16F74, 16F747, 16F76, 16F767, 16F77, 16F777, 16F785, 16F818, 16F819, 16F83, 16F84, 16F84A, 16F87, 16F870, 16F871, 16F872, 16F873, 16F873A, 16F874, 16F874A, 16F876, 16F876A, 16F877, 16F877A, 16F88, 16F883, 16F884, 16F886, 16F887, 16F913, 16F914, 16F916, 16F917, 16F946

18F1220, 18F1230, 18F1320, 18F1330, 18F2220, 18F2221, 18F2320, 18F2321, 18F2331, 18F2410, 18F242, 18F2420, 18F2423, 18F2431, 18F2439, 18F2450, 18F2455, 18F248, 18F2480, 18F24J10, 18F2510, 18F2515, 18F252, 18F2520, 18F2523, 18F2525, 18F2539, 18F2550, 18F258, 18F2580, 18F2585, 18F25J10, 18F2610, 18F2620, 18F2680, 18F2682, 18F2685, 18F4220, 18F4221, 18F4320, 18F4321, 18F4331, 18F4410, 18F442, 18F4420, 18F4423, 18F4431, 18F4439, 18F4450, 18F4455, 18F448, 18F4480, 18F44J10, 18F4510, 18F4515, 18F452, 18F4520, 18F4523, 18F4525, 18F4539, 18F4550, 18F458, 18F4580, 18F4585, 18F45J10, 18F4610, 18F4620, 18F4680, 18F4682, 18F4685, 18F6310, 18F6390, 18F6410, 18F6490, 18F6527, 18F6622, 18F6627, 18F6722, 18F8310, 18F8390, 18F8410, 18F8490, 18F8527, 18F8622, 18F8627, 18F8722

Target microcontrollers - AVR

ATtiny13, ATtiny2313, ATtiny24, ATtiny25, ATtiny26, ATtiny261, ATtiny44, ATtiny45, ATtiny461, ATtiny84, ATtiny85, ATtiny861

ATmega16, ATmega162, ATmega164P, ATmega168, ATmega32, ATmega324P, ATmega328P, ATmega48, ATmega644, ATmega8, ATmega8515, ATmega8535, ATmega88

Note that microcontroller compatibility changes on a frequent basis. If you have specific microcontroller requirements then please contact your dealer.

Order codes

Flowcode for PICmicro MCUs

Student version:	TEFLCST3
Pro version:	TEFLCSI3
I0 user education version:	TEFLCI03
Site licence education version:	TEFLCSL3

Flowcode for AVR MCUs

Student version:	TEVRST3
Pro version:	TEVRSI3
I0 user education version:	TEVRI03
Site licence education version:	TEVRSI3